

8ft Fabric Straight Popup with End Cap

Graphic Specifications

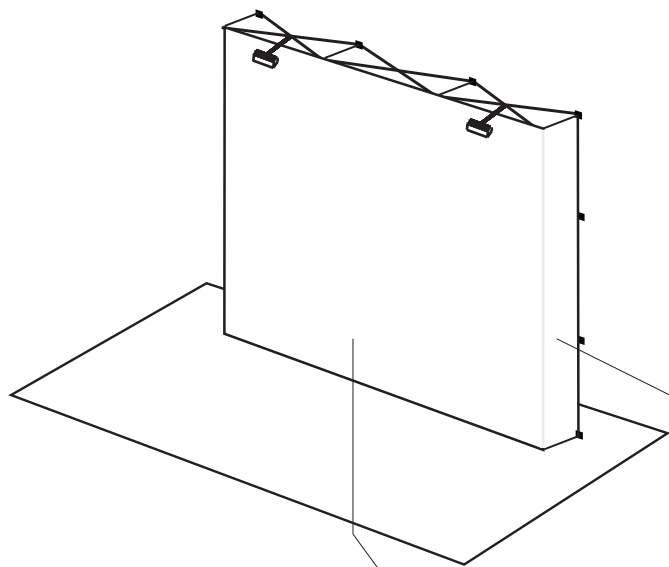

- 100 dpi
- CMYK
- Actual Size
- JPEG/TIFF file

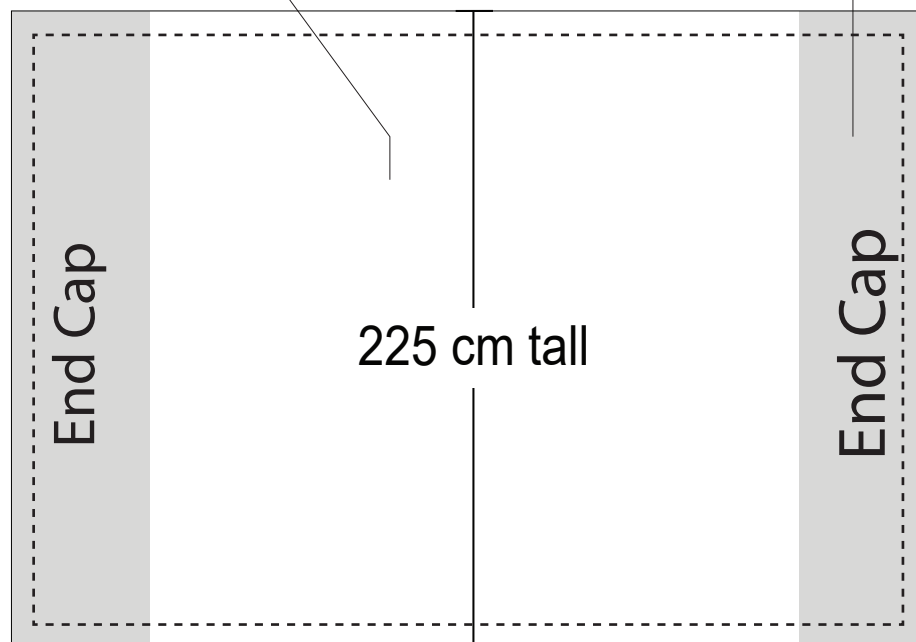

--- The stitch is 5 cm from the edges.

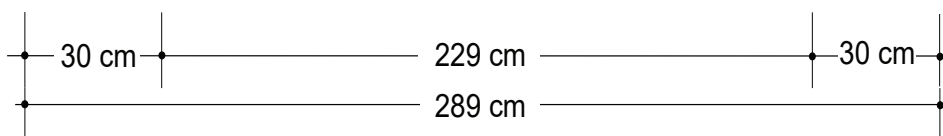

*Design Tips:

Limit Gradient Effects

We don't suggest you to use any gradient effect because when you look closely to the print, you will see transition lines. If you really need to use it, our acceptance level is looking from 2 meters away, the transition lines would be barely visible. Please contact us for further clarification.

